BuzziScreen

Product Specification Sheet

This document contains technical information about the BuzziScreen



www.buzzi.space



Sound absorbing dividing screen

The folding screen has come back into fashion with a bang!

The BuzziScreen is a contemporary take on the flexible room divider with all sorts of advantages.

For example, it can be extended infinitely: the handy recycled zipper system makes it easy for you to add panels. Just like with other BuzziSpace products, you can pin objects, photos or letters to the screen, and of course it works as sound absorption as well. Divide your office or room however you want, wherever you want!

Design by Sas Adriaenssens

General

 S | M | L

Cover: BuzziFelt

 Core: honeycomb cardboard
(rubber strip)
Zipper in orange or black

 S: H 120 cm W 80 cm
 H 47.24" W 31.50"
M: H 150 cm W 80 cm
 H 59.06" W 31.50"
L: H 200 cm W 80 cm
 H 78.74" W 31.50"

 S: 4,2 kg
 9.26 lbs
M: 5 kg
 11.02 lbs
L: 6,3 kg
 13.89 lbs

 Dry use

 Flat packed

Bicolour

 BuzziFoot: extra support in powder coated metal Black (RAL 9005) or Alu color (RAL 9006)
Extra layer in Fabric, Rough, Trevira CS+ | CS, Revive 1, Revive 2, Terra, Clara 2, Remix 2, Hero, Tonus 4, Tonus Meadow, Memory 2, Matrix

Acoustics



Attenuation

Content

Panels	3	Dimensions	9
Combinations: examples	4	Acoustics	10
Fabrics	5		

Panels

Puller Side

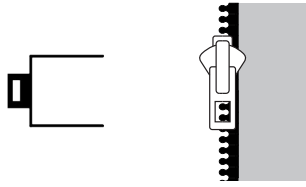

Pin Side

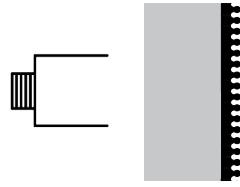

1-Stop panel

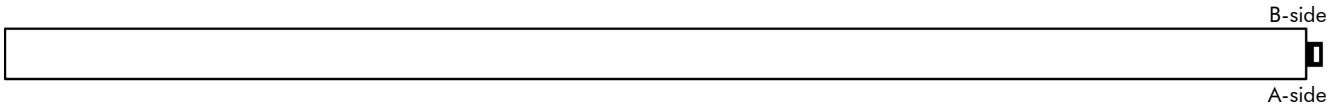

2-Start panel

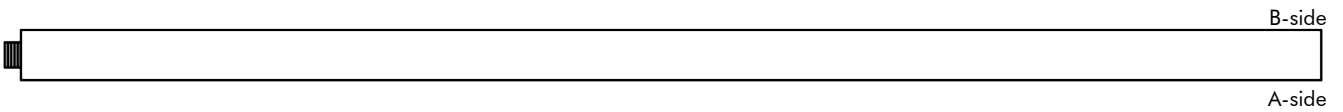

3-Mid panel

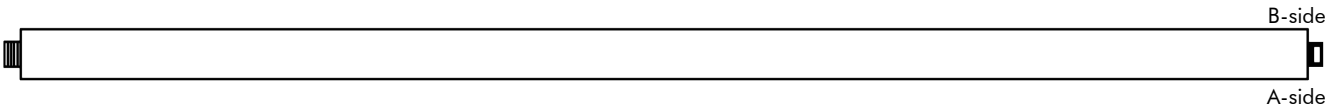

4-Stop extra panel

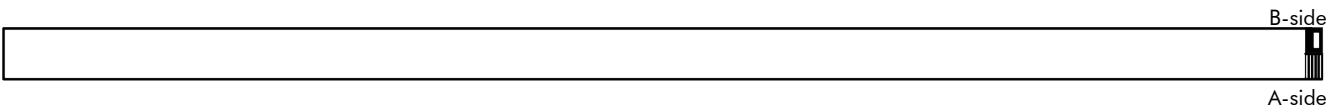

5-Start extra panel

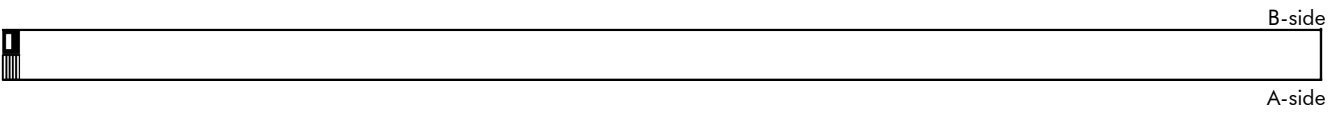

6-Mid extra R panel

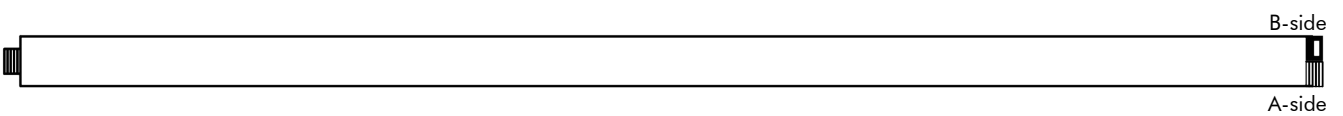

7-Mid extra L panel

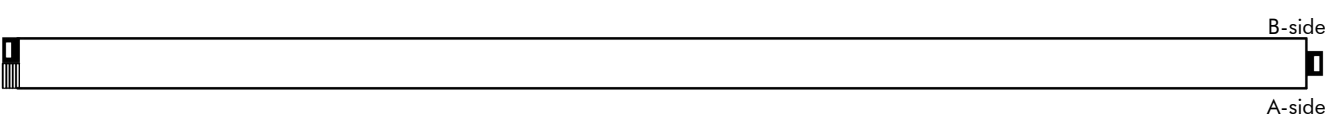

8-Mid extra plus panel

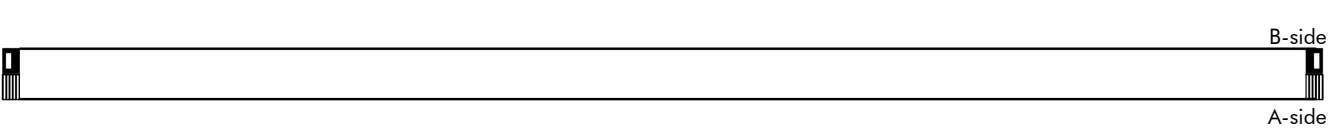

Combinations: examples

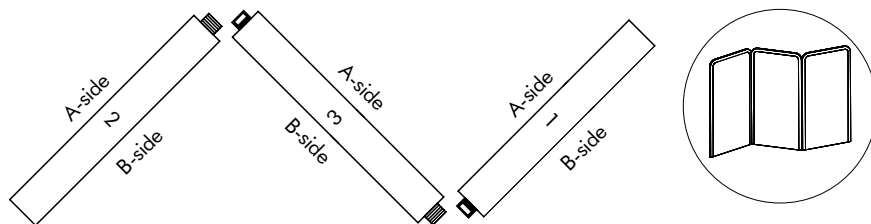
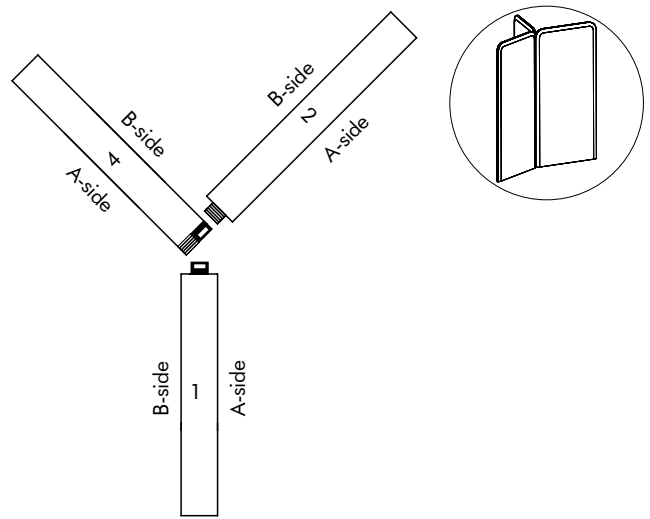
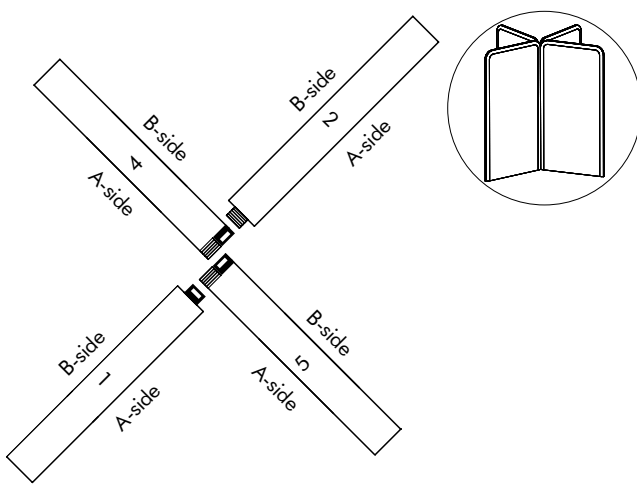
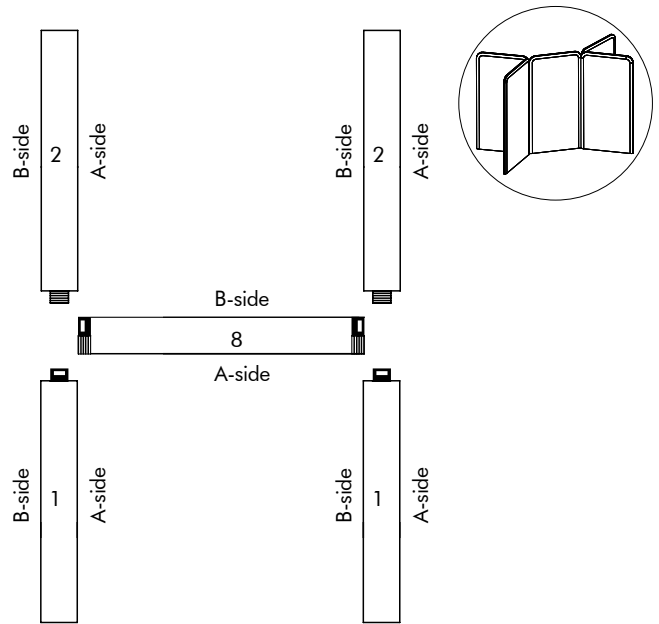
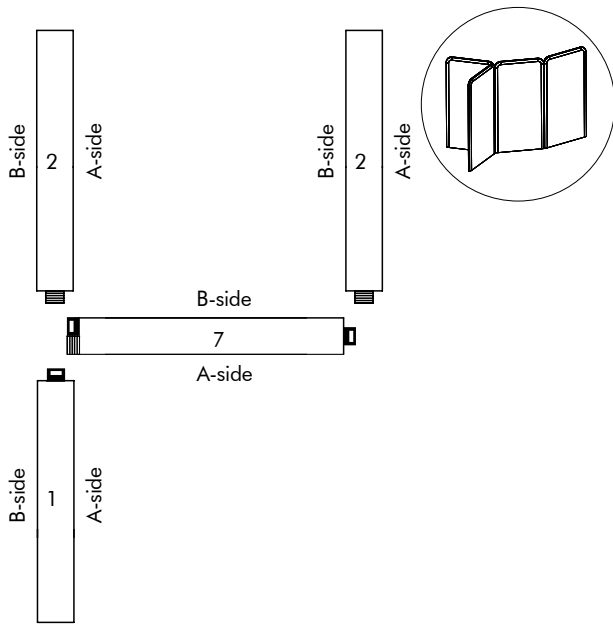

It's not recommended to put several BuzziScreens in one straight line (go zigzag!)

Fabrics

Felt

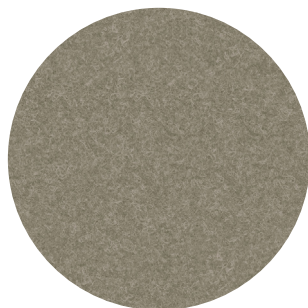

Composition 100% Recycled P.E.T. Felt
Weight 1.000 g/m² | 29.49 oz/yd²
Abrasion resistance >7.000 Martindale
Flammability EU: EN 13501.1+A1/2009
BS476 Part 6 and 7 Class 0
USA: ASTM E84 Class A certified
Fastness to light USA 5



Fabric

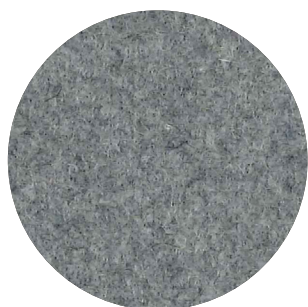

Category A
Composition 70% Recycled Wool, 25% Recycled Polyacryl,
5% Recycled Other Fabrics
Weight 405 g/m² | 11.94 oz/yd²
Abrasion resistance 40.000 Martindale, 50,000 Wyzenbeek
Flammability EU: EN 1021.1/2006 | BS EN 1021.1/2006 (cigarette).
EN 1021.2/2006 | BS EN 1021.2/2006 (match)
USA: CAL TB 117 | ASTM E84 CLASS A
Fastness to light EU: 4 | USA 4
Fastness to rubbing EU: Wet 3-4 | Dry 4-5
Fastness to crocking USA: Wet 5 | Dry 5



Rough



Category A
Composition 100% Polyacryl
Weight 456 g/m² | 13.45 oz/yd²
Abrasion resistance 40.000 Martindale
Flammability EU: EN 1021.1/2006 | BS EN 1021.1/2006 (cigarette)
USA: CAL TB TB 117
Fastness to light EU: 5
Fastness to rubbing EU: Wet: 3 | Dry: 3



Trevira CS+ | CS

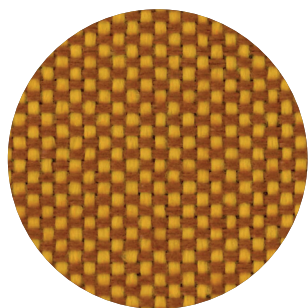

Category A
Weight 420 g/m² | 12.39 oz/yd²
Composition 100% Polyester, Trevira CS
Abrasion resistance 100.000 Martindale, 90,000 Wyzenbeek
Flammability BS 5852 part II: CRIB 5 | BS 7176 Medium Hazard
USA: CAL TB 117 | M1 | B1 | EN 1021/1-2 | C1 |
IMO Res. A652 (16)
Fastness to light EU: 6 | USA 5
Fastness to rubbing EU: Wet 4-5 | Dry 4-5
Fastness to crocking USA: Wet 5 | Dry 5



Revive 1

kvadrat

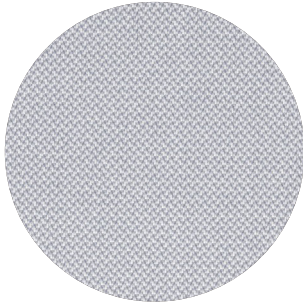

Category A

Composition 100% recycled polyester FR

Weight 430 g/lin.m

Abrasion resistance 60.000 Martindale rubs, EN ISO 12947

Flammability EN 1021-1/2 | DIN 4102 B1 | Önorm B1/Q1
UNI 9175 1IM | US Cal. Tech. Bull. 117
IMO A.652 (16)

Fastness to light Note 5-7, ISO 105-B02

Fastness to rubbing (ISO) dry 5, wet 4-5

Pilling Note 4-5, EN ISO 12945



Revive 2

kvadrat

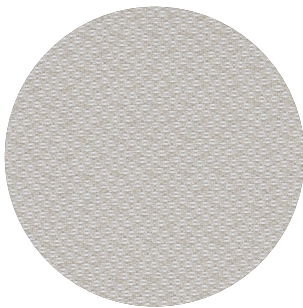

Category A

Composition 100% recycled polyester FR

Weight 420 g/lin.m

Abrasion resistance 45.000 Martindale rubs, EN ISO 12947

Flammability EN 1021-1/2 | DIN 4102 B1 | Önorm B1/Q1
UNI 9175 1IM | US Cal. Tech. Bull. 117
IMO A.652 (16)

Fastness to light Note 5-7, ISO 105-B02

Fastness to rubbing (ISO) dry 5, wet 4-5

Pilling Note 4-5, EN ISO 12945



Terra

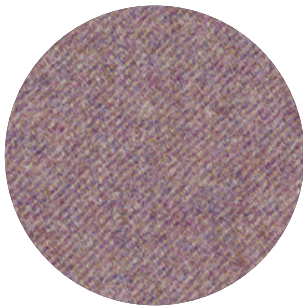

Category B

Composition 100% Pure New Wool

Weight 370 g/m² | 10.91 oz/yd²

Abrasion resistance 40.000 Martindale, 25,000 Wyzenbeek

Flammability EU: BS5852 CRIB 5 | BS5867 PART 2 : 2008 : TYPE B
EN: 1021.2/2006 | USA: CAL TB 117

Fastness to light EU 5 | USA 5

Fastness to rubbing EU: Wet 4 | Dry 4

Fastness to crocking USA: Wet 4 | Dry 4



Clara 2

kvadrat

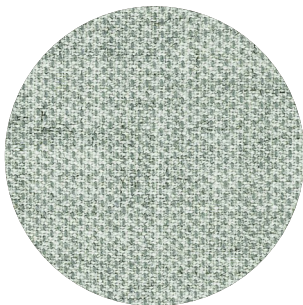

Category B

Composition 92% new wool, 8% nylon

Weight 400 g/lin.m

Abrasion resistance 80.000 Martindale rubs, EN ISO 12947

Flammability EN 1021-1/2 | BS 5852, ignition source 2-3 | DIN 4102 B2
NF D 60 013 | UNI 9175 1IM | US Cal. Tech. Bull. 117, Sec. E
NFPA 260 | IMO A.652(16)

Fastness to light Note 5-7, ISO 105-B02

Fastness to rubbing (ISO) dry 4-5, wet 4

Pilling Note 4, EN ISO 12945



Hero

kvadrat

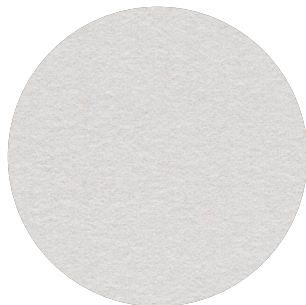

Category C

Composition 96% new wool, 4% nylon

Weight 580 g/lin.m

Abrasion resistance 45.000 Martindale rubs, EN ISO 12947

Flammability EN 1021-1/2 | DIN 4102 B2 | NF D 60 013
UNI 9175 11M | US Cal. Bull. 117-2013 | NFPA 260
IMO A.652 (16)

Fastness to light Note 5-6, ISO 105-B02

Fastness to rubbing (ISO) dry 4-5, wet 4-5

Pilling Note 3-4, EN ISO 12945



Tonus 4

kvadrat

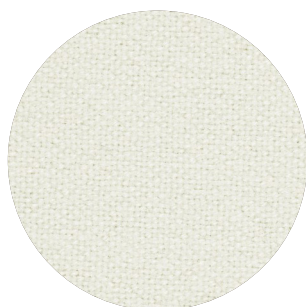

Category D

Composition 90% new wool, 10% Helanca

Weight 665 g/lin.m

Abrasion resistance 100.000 Martindale rubs, EN ISO 12947

Flammability EN 1021-1/2 | BS 5852 part 1 | DIN 4102 B2
Önorm B1/Q1 | NF D 60 013 | UNI 9175 11M
US Cal. Bull. 117-2013 | NFPA 260 | IMO A.652 (16)

Fastness to light Note 5-7, ISO 105-B02

Fastness to rubbing (ISO) dry 3-5, wet 3-5

Pilling Note 3, EN ISO 12945



Tonus Meadow

kvadrat

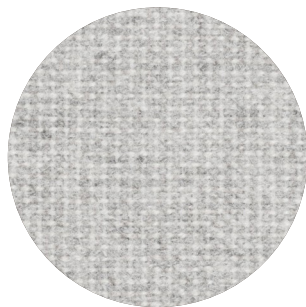

Category D

Composition 90% new wool, 10% Helanca

Weight 665 g/lin.m

Abrasion resistance 100.000 Martindale rubs, EN ISO 12947

Flammability EN 1021-1/2 | BS 5852 part 1 | DIN 4102 B2
Önorm B1/Q1 | NF D 60 013 | UNI 9175 11M
US Cal. Bull. 117-2013 | NFPA 260 | IMO A.652 (16)

Fastness to light Note 5-7, ISO 105-B02

Fastness to rubbing (ISO) dry 4-5, wet 4

Pilling Note 3, EN ISO 12945



Memory 2

kvadrat

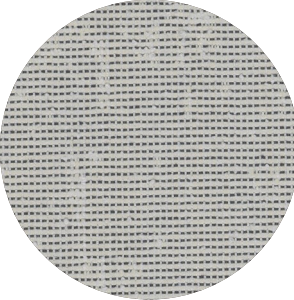

Category E

Composition 100% Trevira CS

Weight 700 g/lin.m

Abrasion resistance

35.000 rubs acc. to the Martindale method, EN ISO 12947

Flammability EN 1021-1/2 | DIN 4102 B1 | Önorm B1/Q1
NF D 60 013 | NF P 92 507 M1 | UNI 9175 11M
UNI 9177 classe 1 | US Cal. Tech. Bull. 117
IMO A.652 (16)

Fastness to light Note 5-8, ISO 105-B02

Fastness to rubbing (ISO) dry 4-5, wet 4-5

Pilling Note 4, EN ISO 12945



Matrix

kvadrat

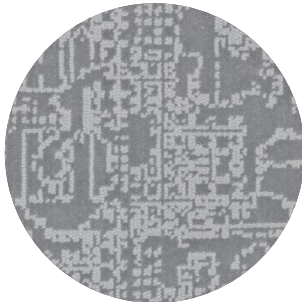

Category F

Composition 100% Trevira CS

Weight 760 g/lin.m

Abrasion resistance

App. 60.000 rubs acc. to the Martindale method, EN ISO 12947

Flammability EN 1021-1/2 | BS 5852 crib 5 | BS 5867 part 2 type B
DIN 4102 B1 | Önorm B1/Q1 | NF D 60 013
UNI 9175 11M | US Cal. Tech. Bull. 117 | NFPA 701
IMO A.652 (16)

Fastness to light Note 5-7, ISO 105-B02

Fastness to rubbing (ISO) dry 4-5, wet 4-5

Pilling Note 4, EN ISO 12945



Dimensions

BuzziScreen

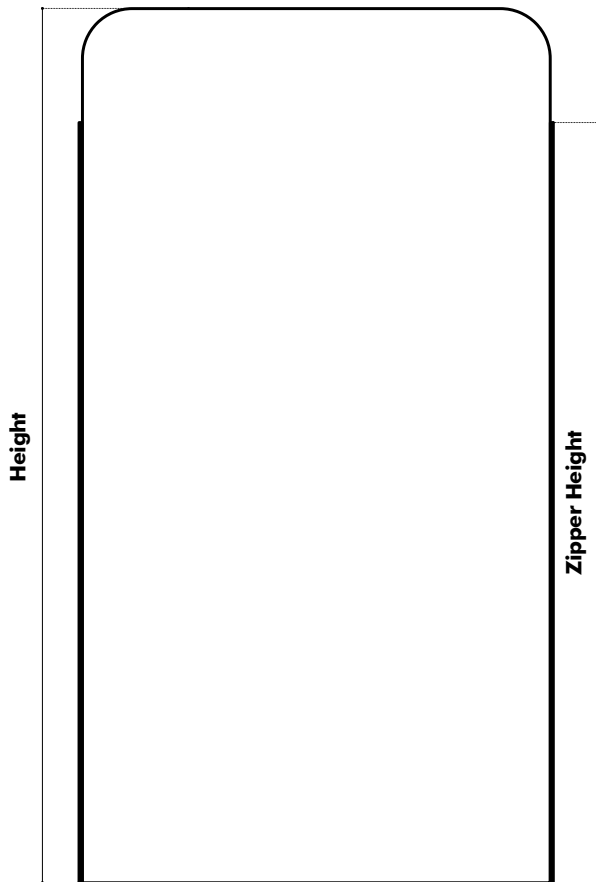

BuzziFoot

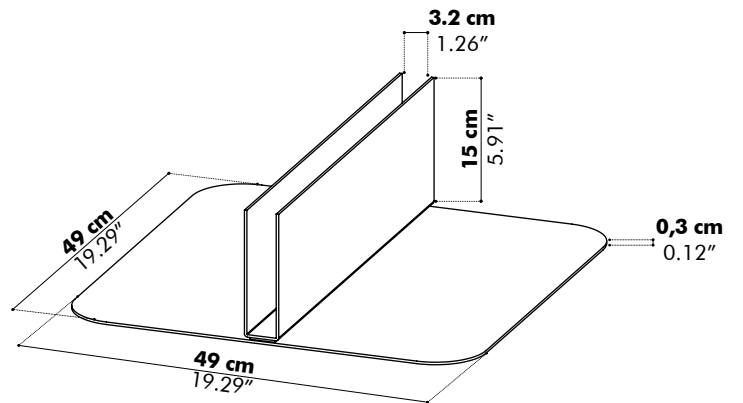

BuzziScreen

	Height		Zipper Height	
S	120 cm	47.24"	100 cm	39.37"
M	150 cm	59.06"	130 cm	51.18"
L	200 cm	78.74"	180 cm	70.87"

Acoustics

Equivalent sound absorption area in m² per object

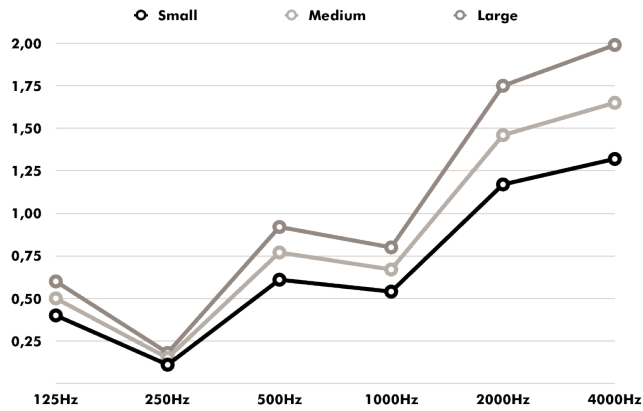

Hz	Small Aeq/m ²	Medium Aeq/m ²	Large Aeq/m ²
125	0,40	0,50	0,60
250	0,11	0,15	0,18
500	0,61	0,77	0,92
1000	0,54	0,67	0,80
2000	1,17	1,46	1,75
4000	1,32	1,65	1,99